

IGBT MODULE (S series) 600V / 30A / PIM



■ Features

- Low $V_{CE(sat)}$
- Compact package
- P.C. board mount
- Converter diode bridge, Dynamic brake circuit

■ Applications

- Inverter for motor drive
- AC and DC servo drive amplifier
- Uninterruptible power supply

■ Maximum ratings and characteristics

● Absolute maximum ratings ($T_c=25^\circ\text{C}$ unless without specified)

Item	Symbol	Condition	Rating	Unit	
Inverter	Collector-Emitter voltage	V_{CES}	600	V	
	Gate-Emitter voltage	V_{GES}	± 20	V	
	Collector current	I_C	Continuous	30	A
		I_{CP}	1ms	60	A
		$-I_C$		30	A
Collector power dissipation	P_C	1 device	120	W	
Brake	Collector-Emitter voltage	V_{CES}	600	V	
	Gate-Emitter voltage	V_{GES}	± 20	V	
	Collector current	I_C	Continuous	20	A
		I_{CP}	1ms	40	A
	Collector power dissipation	P_C	1 device	80	W
Converter	Repetitive peak reverse voltage	V_{RRM}	600	V	
	Repetitive peak reverse voltage	V_{RRM}	800	V	
	Average output current	I_O	50Hz/60Hz sine wave	30	A
	Surge current (Non-Repetitive)	I_{FSM}	$T_j=150^\circ\text{C}$, 10ms	210	A
	I^2t (Non-Repetitive)	I^2t	half sine wave	221	A^2s
Operating junction temperature	T_j		+150	$^\circ\text{C}$	
Storage temperature	T_{stg}		-40 to +125	$^\circ\text{C}$	
Isolation between terminal and copper base *2	V_{iso}	AC : 1 minute	AC 2500	V	
			AC 2500	V	
voltage between thermistor and others *3			AC 2500	V	
Mounting screw torque			3.5 *1	N·m	

*1 Recommendable value : 2.5 to 3.5 N·m (M5)

*2 All terminals should be connected together when isolation test will be done.

*3 Terminal 8 and 9 should be connected together. Terminal 1 to 7 and 10 to 24 should be connected together and shorted to copper base.

● Electrical characteristics (T_j=25°C unless otherwise specified)

Item	Symbol	Condition	Characteristics			Unit			
			Min.	Typ.	Max.				
Inverter	Zero gate voltage collector current	ICES	V _{CE} =600V, V _{GE} =0V			1.0	mA		
	Gate-Emitter leakage current	IGES	V _{CE} =0V, V _{GE} =±20V			0.2	μA		
	Gate-Emitter threshold voltage	V _{GE(th)}	V _{CE} =20V, I _c =30mA			5.5	7.8	8.5	V
	Collector-Emitter saturation voltage	V _{CE(sat)}	V _{GE} =15V, I _c =30A	chip	1.8		2.4	V	
				terminal	1.95				
	Input capacitance	C _{ies}	V _{GE} =0V, V _{CE} =10V, f=1MHz			3000		pF	
	Turn-on time	ton	V _{CC} =300V			0.45	1.2	μs	
		tr	I _c =30A			0.25	0.6		
		tr(i)	V _{GE} =±15V			0.08			
	Turn-off	toff	R _G =82Ω			0.40	1.0	μs	
tf					0.05	0.35			
Forward on voltage	V _F	I _F =30A	chip	1.8		2.6	V		
			terminal	1.95					
Reverse recovery time of FRD	t _{rr}	I _F =30A			0.3		μs		
Brake	Zero gate voltage collector current	ICES	V _{CEs} =600V, V _{GE} =0V			1.0	mA		
	Gate-Emitter leakage current	IGES	V _{CE} =0V, V _{GE} =±20V			0.2	μA		
	Collector-Emitter saturation voltage	V _{CE(sat)}	I _c =20A, V _{GE} =15V	chip	1.8		2.4	V	
				terminal	1.95				
	Turn-on time	ton	V _{CC} =300V			0.45	1.2	μs	
		tr	I _c =20A			0.25	0.6		
	Turn-off time	toff	V _{GE} =±15V			0.40	1.0	μs	
		tf	R _G =120Ω			0.05	0.35		
	Reverse current	I _{RRM}	V _R =600V			1.0		mA	
	Converter	Forward on voltage	I _F =30A	chip	1.1		1.5	V	
terminal				1.2					
Thermistor	Resistance	R	T=25°C			5000		Ω	
			T=100°C			465	495		520
			T=25/50°C			3305	3375		3450

● Thermal resistance Characteristics

Item	Symbol	Condition	Characteristics			Unit	
			Min.	Typ.	Max.		
Thermal resistance (1 device)	R _{th(j-c)}	Inverter IGBT			1.04		°C/W
		Inverter FWD			2.00		
		Brake IGBT			1.56		
		Converter Diode			1.33		
Contact thermal resistance *	R _{th(c-f)}	With thermal compound			0.05		

* This is the value which is defined mounting on the additional cooling fin with thermal compound

■ Equivalent Circuit Schematic

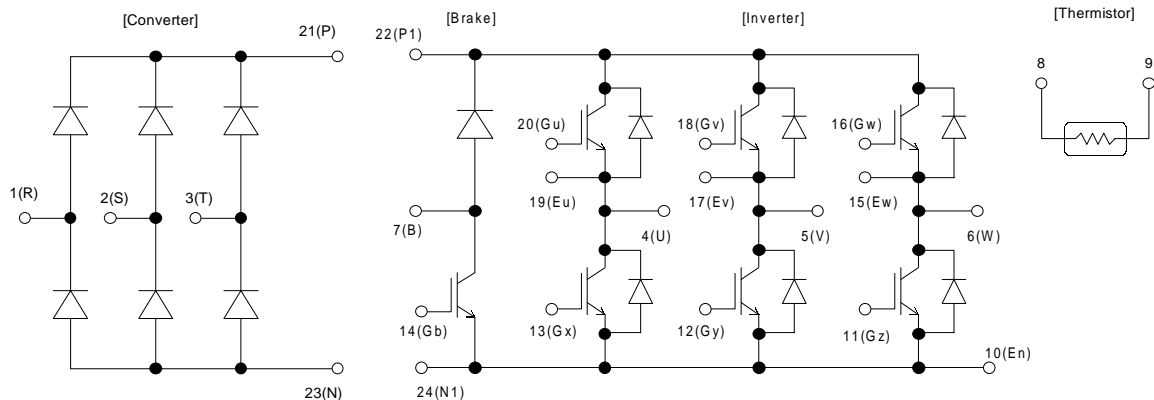

Characteristics (Representative)

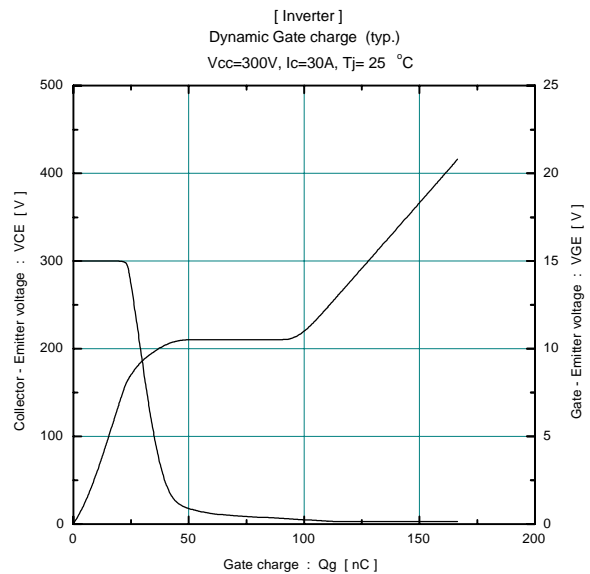
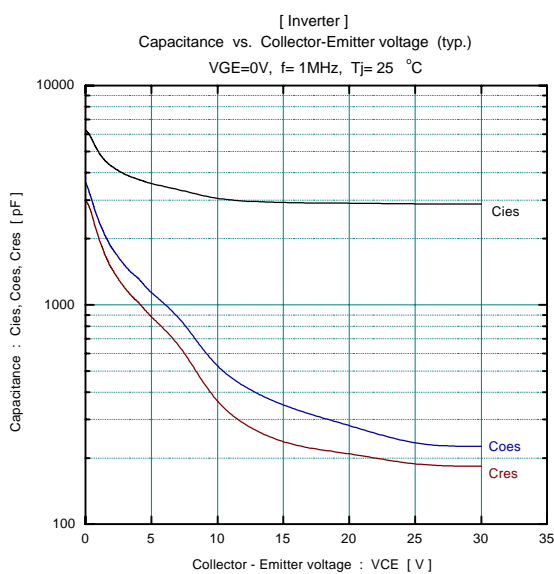
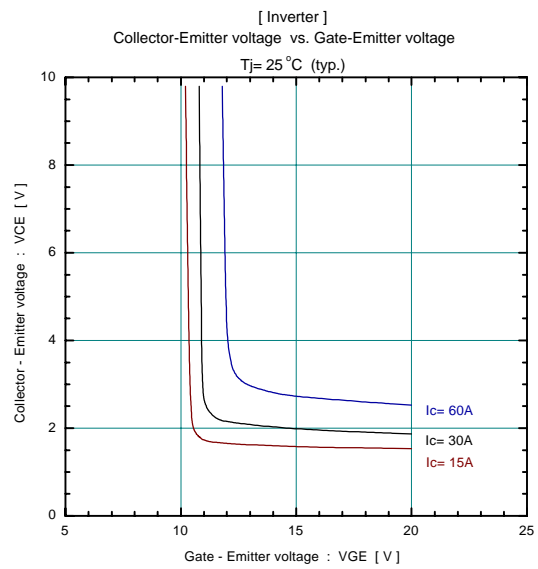
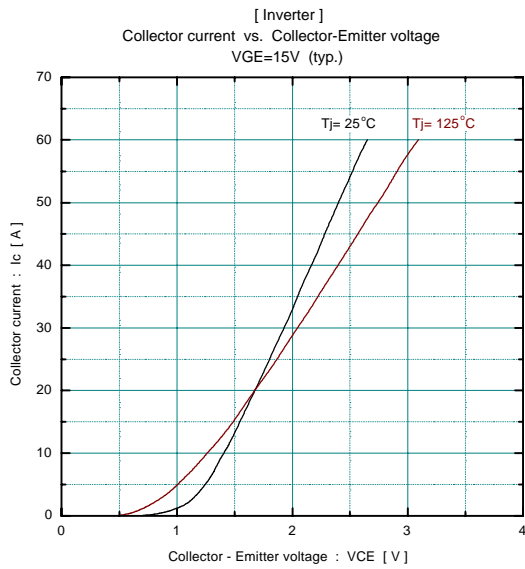
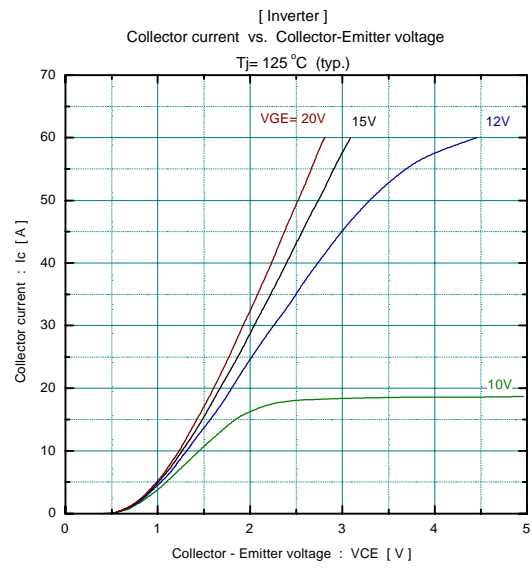
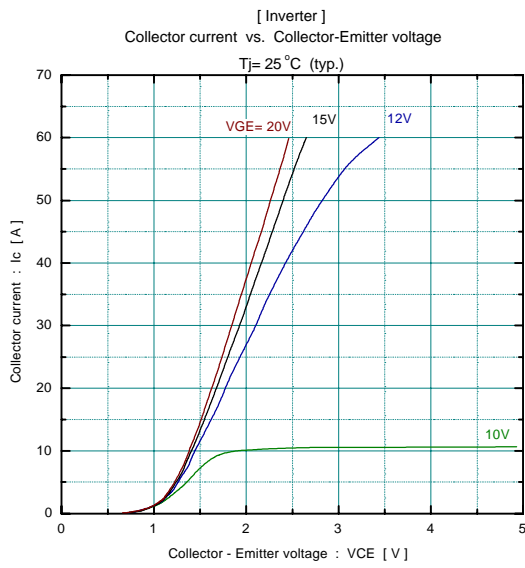

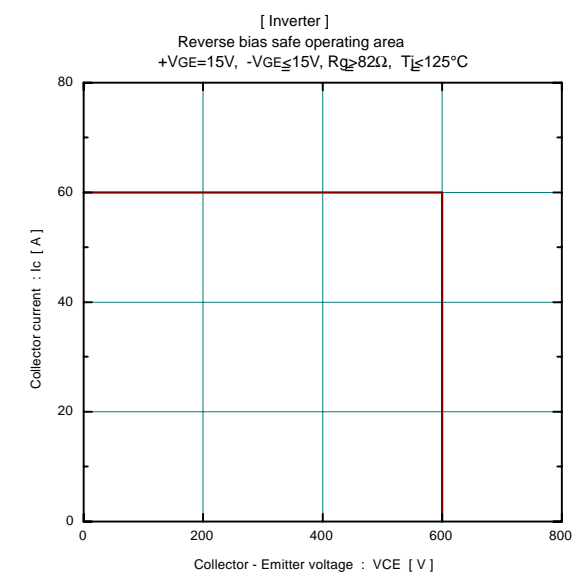
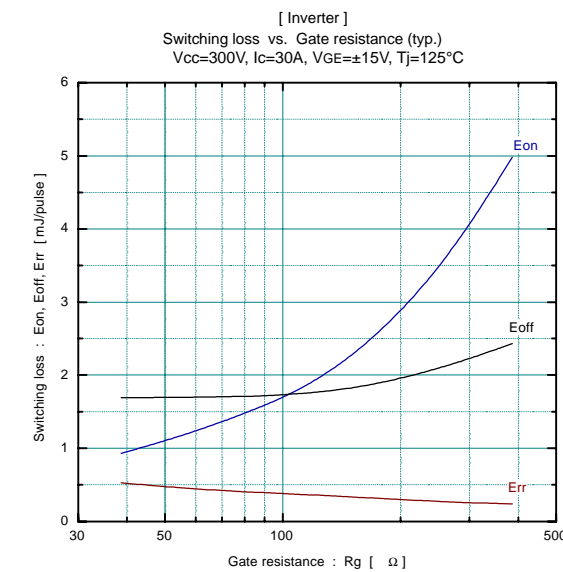
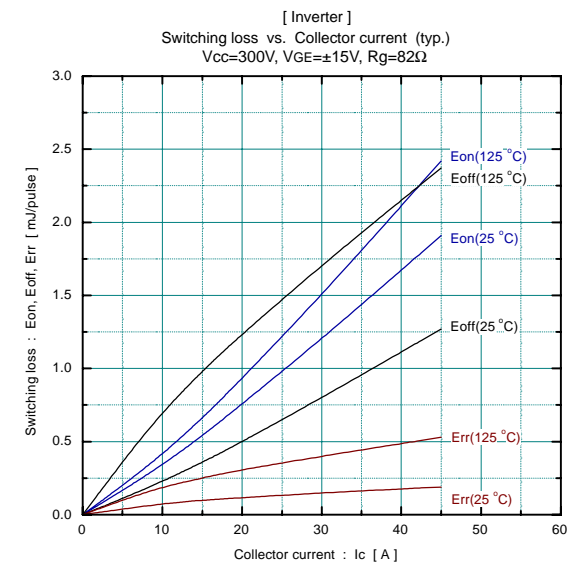
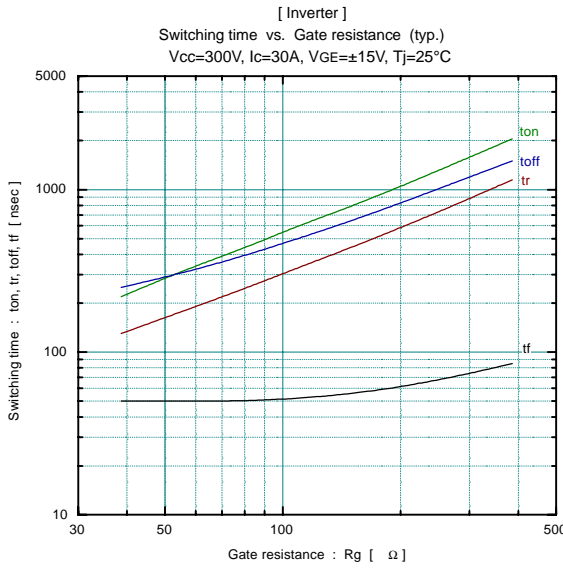
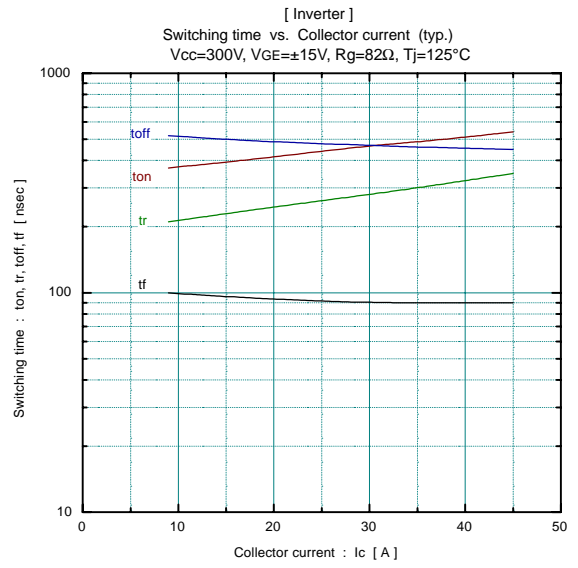
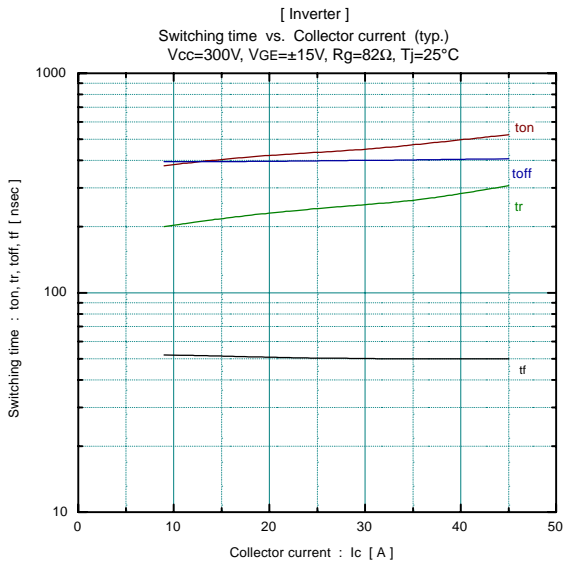

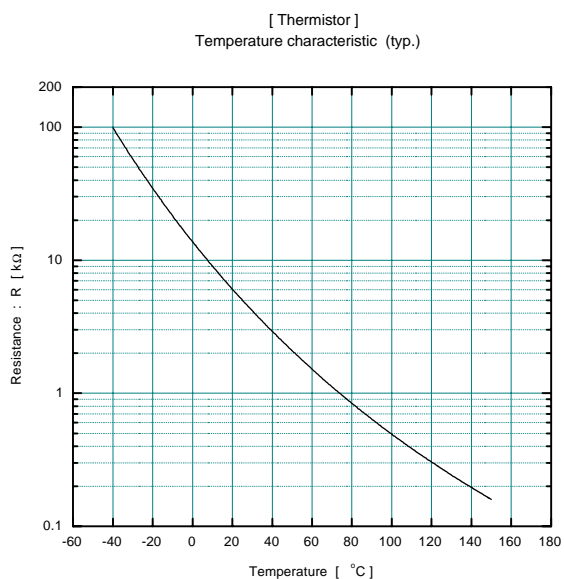
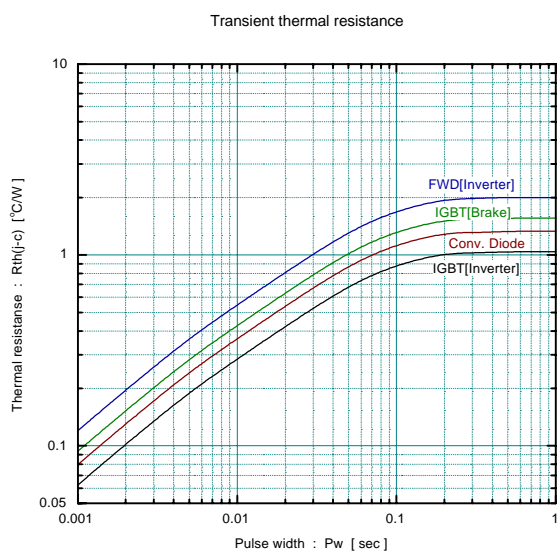
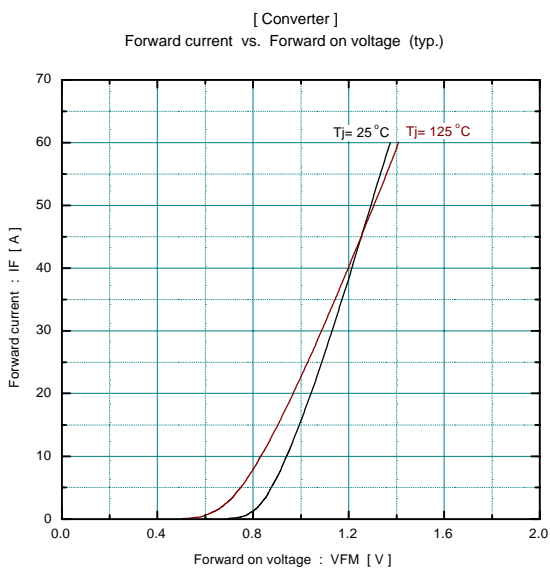
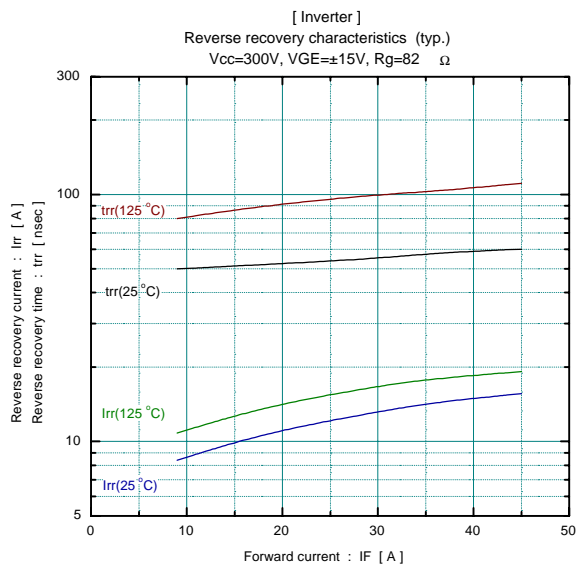
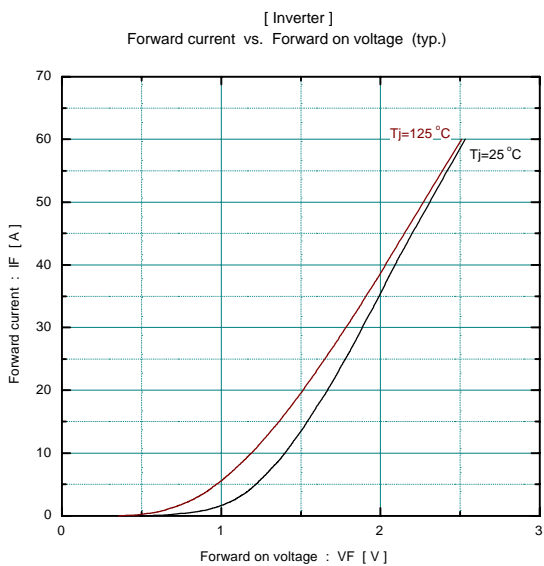

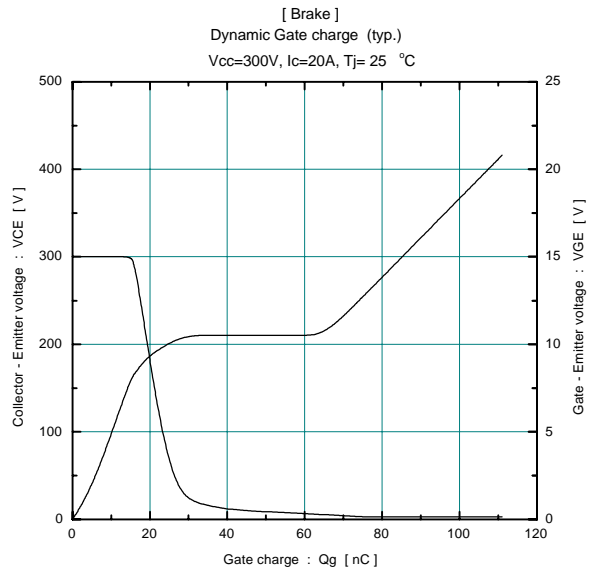
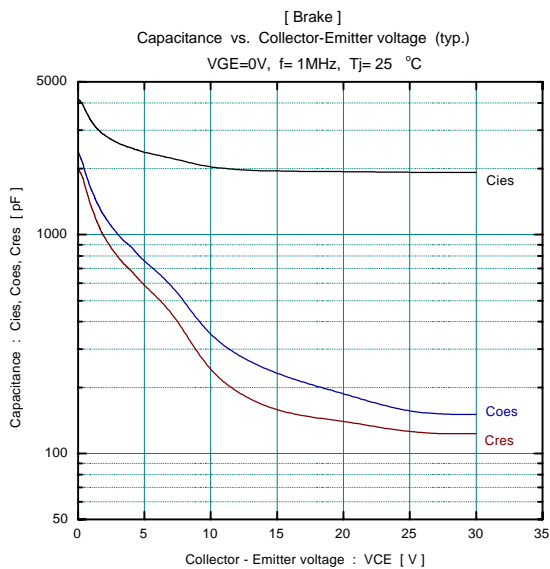
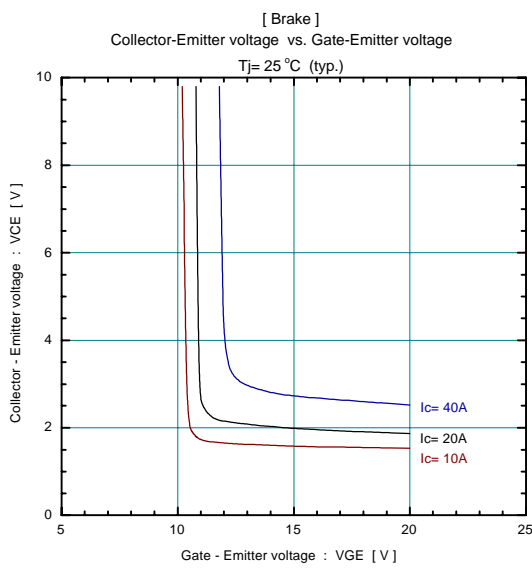
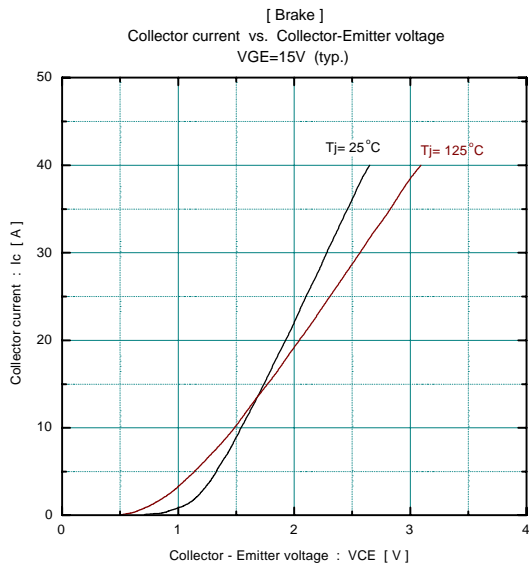
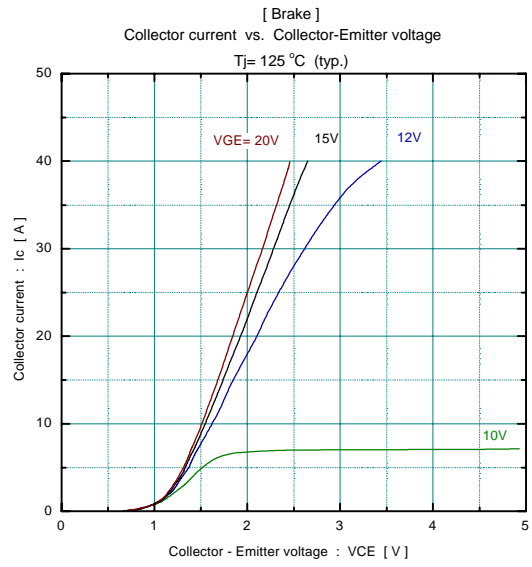
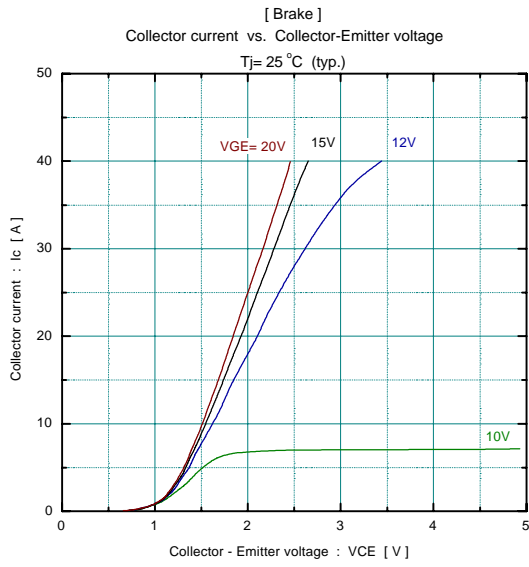

■ Outline Drawings, mm

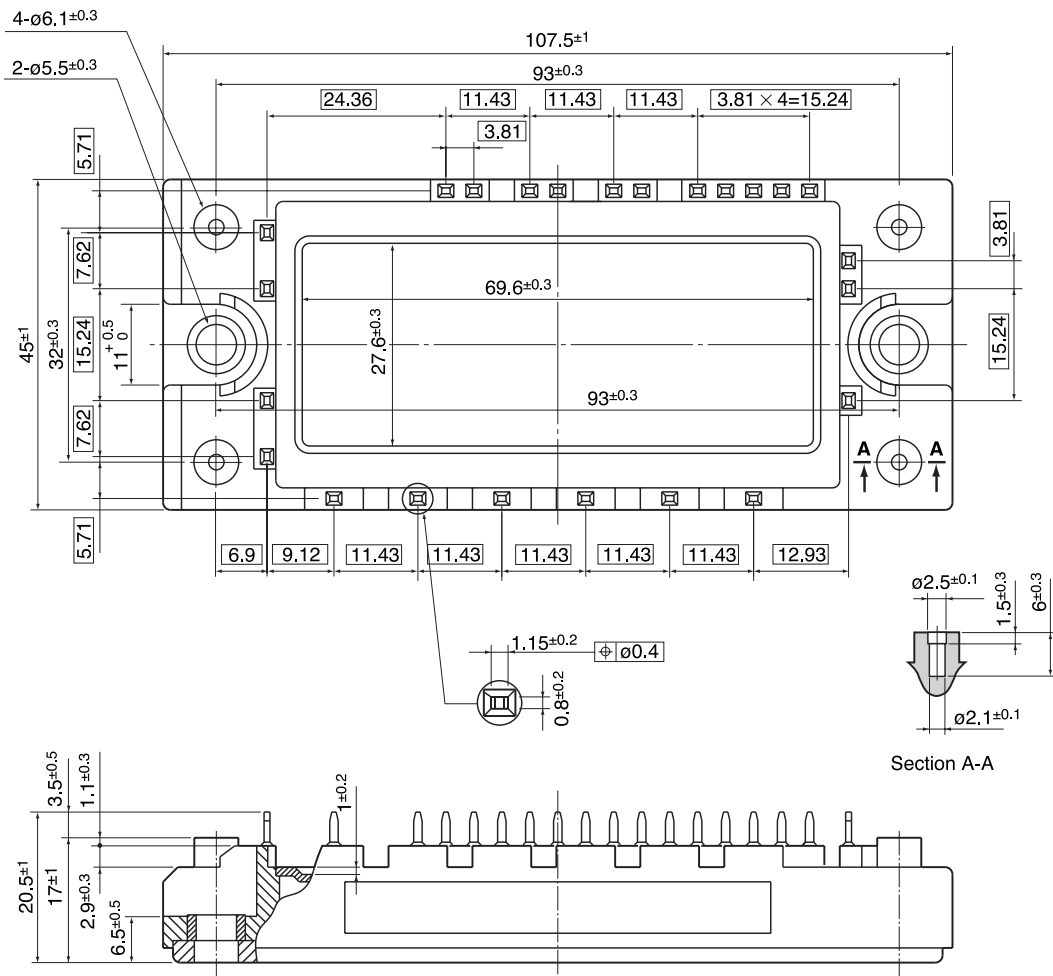

□ Shows theory dimensions